

E-LIFE EPC-415

Industrial Panel PC



GENERAL INFORMATION

- Intel Celeron J1900 2.00 GHZ Quad Core Processor
- Durable and Stylish Aluminum Die Cast Chassis
- 15" Industrial Grade LCD with 450 cd/m2 Brightness
- Multi-Touch Projected Capacitive Touch Screen
- Glove Support on PCAP Touch
- 2 x Gigabit Ethernet
- 4 x RS232 and 1 x RS485 Portu
- 8 Bit Digital I/O
- 3 x USB 2.0 and 1 x USB 3.0
- Remote Power Switch Connector
- CE Certificate of Conformity



EPC-415 is a cost effective and reliable hardware solution for your Industry 4.0, IoT, Automation and Digital Transformation project with its Quad Core Intel Embedded Processor, rich I/O and robust aluminum die casting chassis.

E-Life EPC-415 New Generation Industrial Panel PC is ready to join your projects.

EPC-415 Panel PC, developed with our long-term design experience and market feedback since 2004 that we released our first Panel PC as Turkey's first original design Panel PC manufacturer. New E-Life EPC-415 is offering high performance Celeron J1900 Quad-Core processor, 15" Projected Capacitive (PCAP) Touch Screen and rich I/O ports in a robust but stylish aluminum die cast chassis.

High Quality and Durable PCAP Touch with Glove Support

EPC-415 has industrial grade 15" TFT LCD Display with 450 cd/m2 brightness to ensure smooth user experience in all industrial environment as well as its specially designed Projected Capacitive Touch Sensor with 4 mm total thickness to provide durability and sensitivity during operation. EPC-415's Projected Capacitive sensor provides glove support to ensure seamless touch screen experience at all environments.

Rich I/O Makes Your Connections Easier

EPC-415 has rich I/O port structure including 4xRS232, 1xRS485, 2xGigabit LANs, 2x USB 2.0, 4x USB 3.0, Digital I/O and a remote ON/OFF switch to provide easy operation in case device was panel mounted in a housing. All these features make EPC-415 a flexible and functional Panel PC solution for many industrial applications.

Easy Integration with Flexible Mounting Options

Besides of all enhanced design and technical features, EPC-415 provides flexible mounting and stand options to support different applications at field. EPC-415 has special panel mount fixtures and a silicon gasket around front frame to provide a secure panel mount on customized chassis and housings. In addition, EPC-415 has optional desktop and floor stands and a wall mount bracket provide easy integration in any location.























Technical Specifications



E-LIFE EPC-415

Industrial
Panel PC



 Processor Intel® Celeron J1900 Quad Core 2.00 GHz, 2 MB Cache	 RAM Standard 4 GB DDR3L 1333 MHz (Maks. 8GB)	 SSD Standard 64 GB mSATA SSD 128 GB – 1 TB mSATA SSD SATAIII Options
 Display 15" TFT LCD	 Resolution 1024 x 768	 Brightness 450 cd/m2
 Contrast 700:1	 LCD Viewing Angle (H/V) 160° / 140°	 Touch Screen Projected Capacitive, 5-Points Multi-Touch, Glove Support*
 Serial Ports 4 x RS232 1 x RS485	 USB 3 x USB 2.0 1 x USB 3.0	 LAN 2 x Realtek RTL8111F Gigabit Ethernet
 Digital I/O 4 IN, 4 OUT Digital I/O, RJ48	 Display Output VGA + HDMI	 Graphics Card Intel® HD Graphics
 Audio On board ALC662 High Definition Audio	 Wi-Fi Optional, IEEE 802.11 b/g/n, 5 dBi Wi-Fi Antenna	 Expansion Slot 1 x Mini-PCIe
 PC Power Supply 12V / 5A DC Adaptor	 Power Input 12V DC	 Chassis Aluminum Die Cast
 Mounting Options VESA 100 x 100 Optional Panel Mount Kit Optional Desktop and Kiosk Type Stands Optional Wall Mount Kit	 Operating Temperature 0 ~ 60 °C	 Dimensions 340.5 x 282.5 x 64 mm
 Weight 4.5 Kg.	 Operating Systems Support Windows 10 IoT / Windows 10 Pro	

*Touch Screen glove support is valid for Latex, PVC, Nitrile and PU gloves.

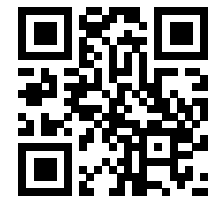
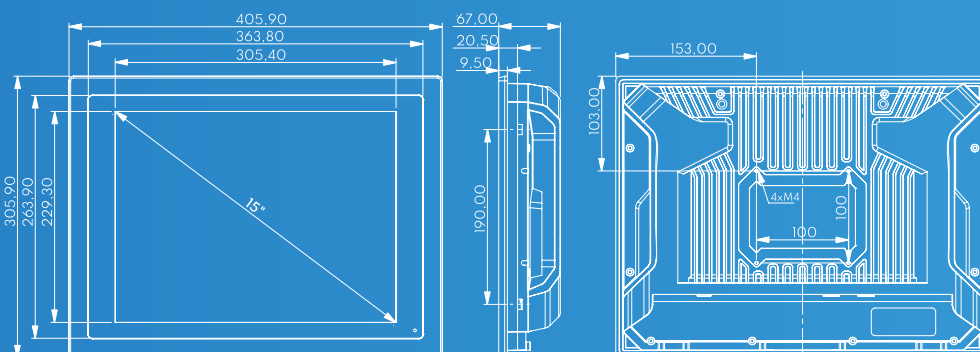

NOYA

NOYA BİLGİSAYAR

Hamidiye Mah. Soğuksu Caddesi
No:5 Kat:8 34408 Kağıthane /
İstanbul / Türkiye

☎ 0212 294 24 03
☎ 0850 399 66 92

info@noyabilgisayar.com
www.noyabilgisayar.com