

E-LIFE EPC-618

Industrial Panel PC



GENERAL INFORMATION

- Intel Celeron J1900 2.00 GHz Quad Core Processor
- Durable and Functional Aluminum Chassis
- 18.5" IPS LCD with 350 cd/m2 Brightness
- Multi-Touch Projected Capacitive Touch Screen
- Glove Support on PCAP Touch
- 2 x Gigabit Ethernet
- 3 x RS232 and 1 x RS485
- 3 x USB 2.0 and 1 x USB 3.0
- Remote Power Switch Connector
- CE Certificate of Conformity

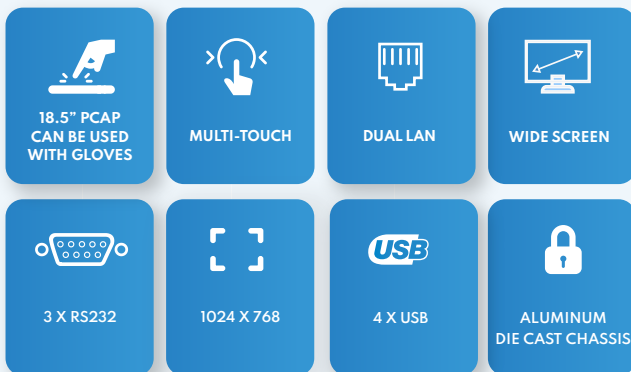

EPC-618 is a cost effective and reliable industrial wide screen Panel PC solution for your Industry 4.0, IoT, Automation and Digital Transformation projects with its 18.5" HD IPS Touch Screen Display, Quad Core Intel Embedded Processor, rich I/O and robust aluminum chassis. EPC-618 Wide Screen Panel PC dedicated to providing non-stop operation at industrial environments.

Wide Screen Comfort and Efficiency for Your Industrial Applications

E-Life EPC-618 has a wide screen IPS display with 1388x786 HD resolution which give more space for your software to contain much more data on display. This will provide a better user experience at filed and increase efficiency of your application.

Durable Multi-Touch PCAP with Glove Support

EPC-618 has 18.5" IPS HD Display with 350 cd/m2 brightness to ensure smooth user experience in all industrial environment as well as its specially designed Projected Capacitive Touch Sensor with 4 mm total thickness to provide durability and sensitivity during operation. EPC-618's Projected Capacitive sensor provides glove support to ensure seamless touch screen experience at all environments.

Stylish and Rugged Aluminum Chassis

E-Life EPC-618 has a unique aluminum extrusion chassis with a stylish design and rugged structure. This ensures EPC-618 will work on harsh industrial environments without any interruption.

Rich I/O and Enhanced Connectivity

E-Life EPC-618 has rich I/O port structure including 3xRS232, 1xRS485, 2xGigabit LANs, 3x USB 2.0, 1x USB 3.0 and a remote ON/OFF switch connector to provide easy operation in case device was panel mounted in a housing. All these features make EPC-618 is a flexible and functional Panel PC solution for many industrial applications.

Easy Integration with Flexible Mounting Options

Besides of all enhanced design and technical features, EPC-618 provides flexible mounting and stand options to support different applications at field. EPC-618 has special panel mount fixtures and a silicon gasket around front frame to provide a secure panel mount on customized chassis and housings. In addition, EPC-618 has optional desktop and floor stands and a wall mount bracket provide easy integration in any location.

























Technical Specifications



E-LIFE EPC-618

Industrial
Panel PC



 Processor Intel® Celeron J1900 Quad Core 2.00 GHz, 2 MB Cache	 RAM Standard 4 GB DDR3L 1333 MHz (Maks. 8GB)	 SSD Standard 64 GB mSATA SSD 128 GB - 1 TB mSATA SSD SATAIII Options
 Display 18.5" TFT LCD	 Resolution 1366 x 768	 Brightness 350 cd/m2
 Contrast 1000:1	 LCD Viewing Angle (H/V) 178° /178°	 Touch Screen Projected Capacitive, 5-Points Multi-Touch, GloveSupport*
 Serial Ports 3 x RS232 1 x RS485	 USB 3 x USB 2.0 1 x USB 3.0	 LAN 2 x Realtek RTL8111F Gigabit Ethernet
 Display Output VGA + HDMI	 Graphics Card Intel® HD Graphics	 Audio On board ALC662 High Definition Audio
 Wi-Fi Optional, IEEE 802.11 b/g/n, 5 dBi Wi-Fi Antenna	 Expansion Slot 1 x Mini-PCIe	 PC Power Supply 12V / 5A DC Adaptor
 Power Input 12V DC	 Chassis Extruded Aluminum	 Mounting Options VESA 100 x 100 Optional Panel Mount Kit Optional Desktop and Kiosk Type Stands Optional Wall Mount Kit
 Operating Temperature 0 ~ 60 °C	 Dimensions 474 x 294 x 53 mm	 Weight 5,75 Kg.
 Operating Systems Support Windows 10 IoT / Windows 10 Pro		

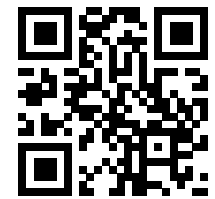
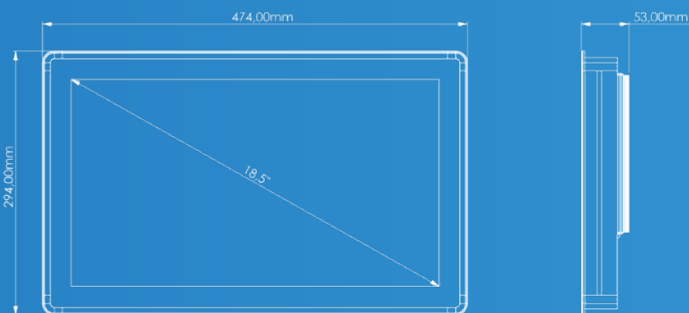

NOYA

NOYA BİLGİSAYAR

Hamidiye Mah. Soğuksu Caddesi
No:5 Kat:8 34408 Kağıthane /
İstanbul / Türkiye

☎ **0212 294 24 03**
☎ **0850 399 66 92**

info@noyabilgisayar.com
www.noyabilgisayar.com