

E-LIFE EPC-410 G2

Industrial Panel PC



GENERAL INFORMATION

- Intel Celeron J4125 2.00 GHz Quad Core Processor
- Durable and Stylish Aluminum Die Cast Chassis
- 10.1" IPS LCD with 430 cd/m2 Brightness
- Optical Bonding Technology on Display
- Multi-Touch Projected Capacitive Touch Screen
- Glove Support on PCAP Touch
- 2 x Gigabit Ethernet
- 2 x RS232
- 2 x USB 3.0
- 9~36V Wide Range DC Input
- Remote Power Switch Connector
- CE Certificate of Conformi

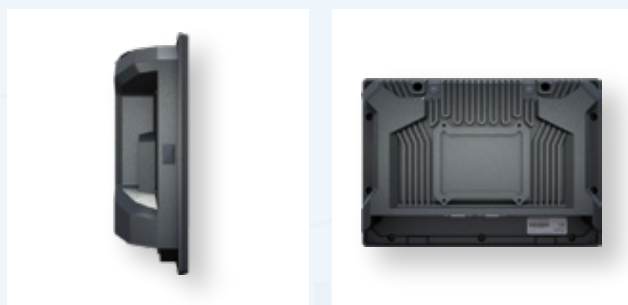
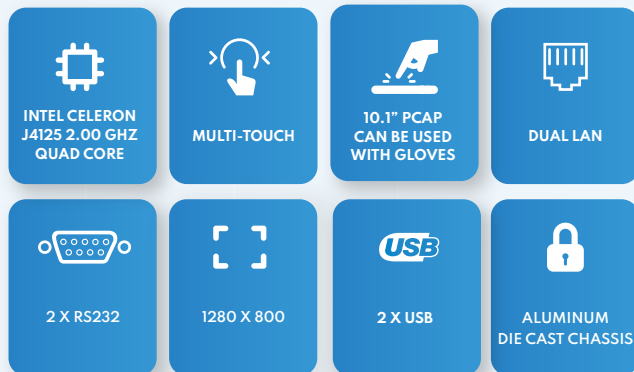

New EPC-410 G2 is a cost effective and compact Panel PC for your Industry 4.0, IoT, Automation and Digital Transformation project with its new generation Quad Core Intel Embedded Processor, rich I/O and robust aluminum die casting chassis.

Compact Yet Powerful

EPC-410 G2 is compact member of new E-Life EPC Panel PC family which is developed to support all applications requires a rugged and compact Panel PC. Like all EPC Series Panel PCs, EPC-410 is also developed with our long-term design experience and market feedback since 2004 that we released our first Panel PC as Turkey's first original design Panel PC manufacturer.

Optical Bonding Technology for High Image Quality and Durability

New EPC-410 G2 has a special 10.1" LCD Display with Optical Bonding Technology and 430 cd/m2 brightness to ensure smooth user experience with high durability and clear images in all industrial environments. Optical Bonding Technology is a special process of laminating cover glass, touch sensor and LCD with a special optical adhesive which eliminates air gap between touch screen and LCD Panel. Displays with Optical Bonding Technology provides high durability and ruggedness against both impacts and severe environmental conditions like dust, humidity and liquids as well as high visibility under bright ambient conditions due to eliminated internal reflection between touch screen and LCD.

EPC-410 G2 has an Optical Bonded PCAP Touch Screen Display by laminating a specially designed 4 mm PCAP Touch Sensor with a 10.1" IPS LCD Panel. Thus EPC-410 G2 is suitable to be deployed at most severe industrial environments with its 10.1" rugged and high sensitivity touch screen with glove support.

Rich I/O Makes Your Connections Easier

EPC-410 G2 has rich I/O port structure including 1xRS232, 2xGigabit LANs, 2x USB 3.0, Digital I/O and a remote ON/OFF switch to provide easy operation in case device was panel mounted in a housing. In addition to all these features, 9~36V Wide Range DC power input of EPC-410 G2 makes it a flexible and functional Panel PC solution for many industrial applications

Easy Integration with Flexible Mounting Options

Besides of all enhanced design and technical features, EPC-410 G2 provides flexible mounting and stand options to support different applications at field. EPC-410 G2 has special panel mount fixtures and a silicon gasket around front frame to provide a secure panel mount on customized chassis and housings. In addition, EPC-410 G2 has optional desktop and floor stands and a wall mount bracket provide easy integration in any location.





























Technical Specifications



E-LIFE EPC-410 G2

Industrial
Panel PC



 Processor Intel® Celeron J4125 Quad Core 2.00 GHz, 4 MB Cache	 RAM Standard 4 GB DDR4 2400 MHz (Maks. 8GB)	 SSD Standard 64 GB M.2 SATAIII SSD 128 GB - 1 TB M.2 SSD SATAIII Options
 Display 10.1" IPS LCD - Optical Bonding Technology	 Resolution 1280 x 800	 Brightness 430 cd/m2
 Contrast 800:1	 LCD Viewing Angle (H/V) 170°/170°	 Touch Screen Projected Capacitive, 5-Points Multi-Touch, Glove Support*
 Serial Ports 2 x RS232 (Optional 4 x RS232 with DIO Port Replacement)	 USB 2 x USB 3.0	 LAN 2 x Realtek RTL8111F Gigabit Ethernet
 Digital I/O 4 IN, 4 OUT Digital I/O, RJ48	 Display Output VGA + HDMI	 Graphics Card Intel® HD Graphics
 Audio On board ALC897 High Definition Audio	 Wi-Fi Optional, IEEE 802.11b/g/n, 5 dBi Wi-Fi Antenna	 Expansion Slot 1 x Mini-PCIe
 PC Power Supply 12V / 5A DC Adaptor	 Power Input 9~36V DC	 Chassis Aluminum Die Cast
 Mounting Options VESA 75x75 Optional Panel Mount Kit Optional Desktop and Kiosk Type Stands Optional Wall Mount Kit	 Operating Temperature 0 ~ 60 °C	 Dimensions 270 x 190 x 59 mm
 Weight 1,95 Kg.	 Operating Systems Support Windows 10 Pro, Windows 10 IoT, Windows 11	

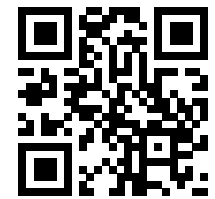
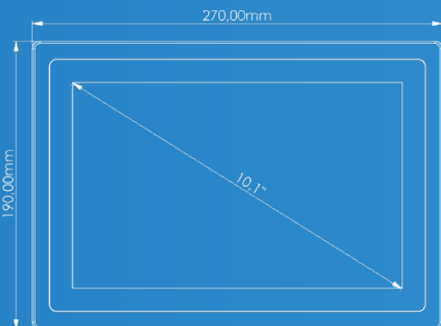

NOYA

NOYA BİLGİSAYAR

Hamidiye Mah. Soğuksu Caddesi
No:5 Kat:8 34408 Kağıthane /
İstanbul / Türkiye

☎ 0212 294 24 03
☎ 0850 399 66 92

info@noyabilgisayar.com
www.noyabilgisayar.com