

# E-LIFE EPC-618 G2

## Industrial Panel PC



### GENERAL INFORMATION

- Intel Celeron J6412 2.00 GHz Quad Core Processor
- Durable and Functional Aluminum Chassis
- 18.5" IPS LCD with 350 cd/m2 Brightness
- Multi-Touch Projected Capacitive Touch Screen
- Glove Support on PCAP Touch
- 2 x Gigabit Ethernet
- 3 x RS232 and 1 x RS485
- 4 x USB 3.2 and 2 x USB 2.0
- Remote Power Switch Connector
- CE Certificate of Conformity



New EPC-618 G2 is a cost effective and reliable wide screen industrial Panel PC solution for your Industry 4.0, IoT, Automation and Digital Transformation projects with its 18.5" HD IPS Touch Screen Display, newest generation Quad Core Intel Embedded Processor, rich I/O and robust aluminum chassis. EPC-618 G2 Wide Screen Panel PC dedicated to providing non-stop operation at industrial environments.

### Higher Performance with New Generation Processor

Combining the advantages of newest generation Intel Celeron J6412 Quad Core processor and DDR4 3200MHz memory technology up to maximum 32GB memory, new EPC-618 G2 offers much higher performance for all applications.

### Durable Multi-Touch PCAP with Glove Support

EPC-618 G2 has 18.5" IPS HD Display with 350 cd/m2 brightness to ensure smooth user experience in all industrial environment as well as its specially designed Projected Capacitive Touch Sensor with 4 mm total thickness to provide durability and sensitivity during operation. EPC-618 G2's Projected Capacitive sensor provides glove support to ensure seamless touch screen experience at all environments.

### Stylish and Rugged Aluminum Chassis

E-Life EPC-618 G2 has a unique aluminum extrusion chassis with a stylish design and rugged structure. This ensures EPC-618 G2 will work on harsh industrial environments without any interruption.

### Rich I/O and Enhanced Connectivity

E-Life EPC-618 G2 has rich I/O port structure including 3xRS232, 1xRS485, 2xGigabit LAN, 4 x USB 3.2, 2 x USB 2.0 and a remote ON/OFF switch connector to provide easy operation in case device was panel mounted in a housing. All these features make EPC-618 G2 is a flexible and functional Panel PC solution for many industrial applications

### Easy Integration with Flexible Mounting Options

Besides of all enhanced design and technical features, EPC-618 G2 provides flexible mounting and stand options to support different applications at field. EPC-618 G2 has special panel mount fixtures and a silicon gasket around front frame to provide a secure panel mount on customized chassis and housings. In addition, EPC-618 G2 has optional desktop and floor stands and a wall mount bracket provide easy integration in any location.







# Technical Specifications



# E-LIFE EPC-618 G2

Industrial  
Panel PC



 <b>Processor</b> Intel® Celeron J6412 Quad Core 2.00 GHz, 1.5 MB Cache	 <b>RAM</b> Standard 4 GB DDR4 3200 MHz (Maks. 32GB)	 <b>SSD</b> Standard 64 GB M.2 SATAIII SSD 128 GB – 1TB M.2 SSD SATAIII Options
 <b>Display</b> 18.5" TFT LCD	 <b>Resolution</b> 1366 x 768	 <b>Brightness</b> 350 cd/m2
 <b>Contrast</b> 1000:1	 <b>LCD Viewing Angle (H/V)</b> 178° /178°	 <b>Touch Screen</b> Projected Capacitive, 5-Points Multi-Touch, GloveSupport*
 <b>Serial Ports</b> 3 x RS232 1 x RS485	 <b>USB</b> 4 x USB 3.2 2 x USB 2.0	 <b>LAN</b> 2 x Realtek RTL8111H Gigabit Ethernet
 <b>Display Output</b> HDMI + DP	 <b>Graphics Card</b> Intel® 10th Generation Processor UHD Graphics	 <b>Audio</b> On board ALC662 High Definition Audio
 <b>Wi-Fi</b> Optional, IEEE 802.11 b/g/n, 5 dBi Wi-Fi Antenna	 <b>Expansion Slot</b> 1 x M.2	 <b>PC Power Supply</b> 12V / 5A DC Adaptor
 <b>Power Input</b> 12V DC	 <b>Chassis</b> Extruded Aluminum	 <b>Mounting Options</b> VESA 100 x 100 Optional Panel Mount Kit Optional Desktop and Kiosk Type Stands Optional Wall Mount Kit
 <b>Operating Temperature</b> 0 ~ 60 °C	 <b>Dimensions</b> 474 x 294 x 53 mm	 <b>Weight</b> 5,75 Kg.
 <b>Operating Systems Support</b> Windows 10 Pro, Windows 10 IoT, Windows 11		

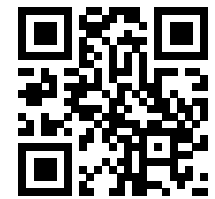
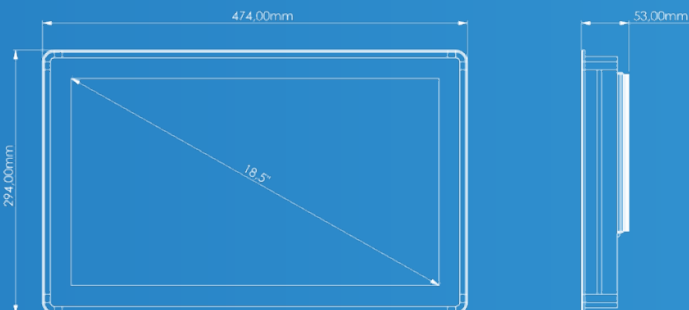

# NOYA

**NOYA BİLGİSAYAR**

Hamidiye Mah. Soğuksu Caddesi  
No:5 Kat:8 34408 Kağıthane /  
İstanbul / Türkiye

☎ **0212 294 24 03**  
☎ **0850 399 66 92**

info@noyabilgisayar.com  
www.noyabilgisayar.com